

## KITCHEN PLANNING GUIDELINES

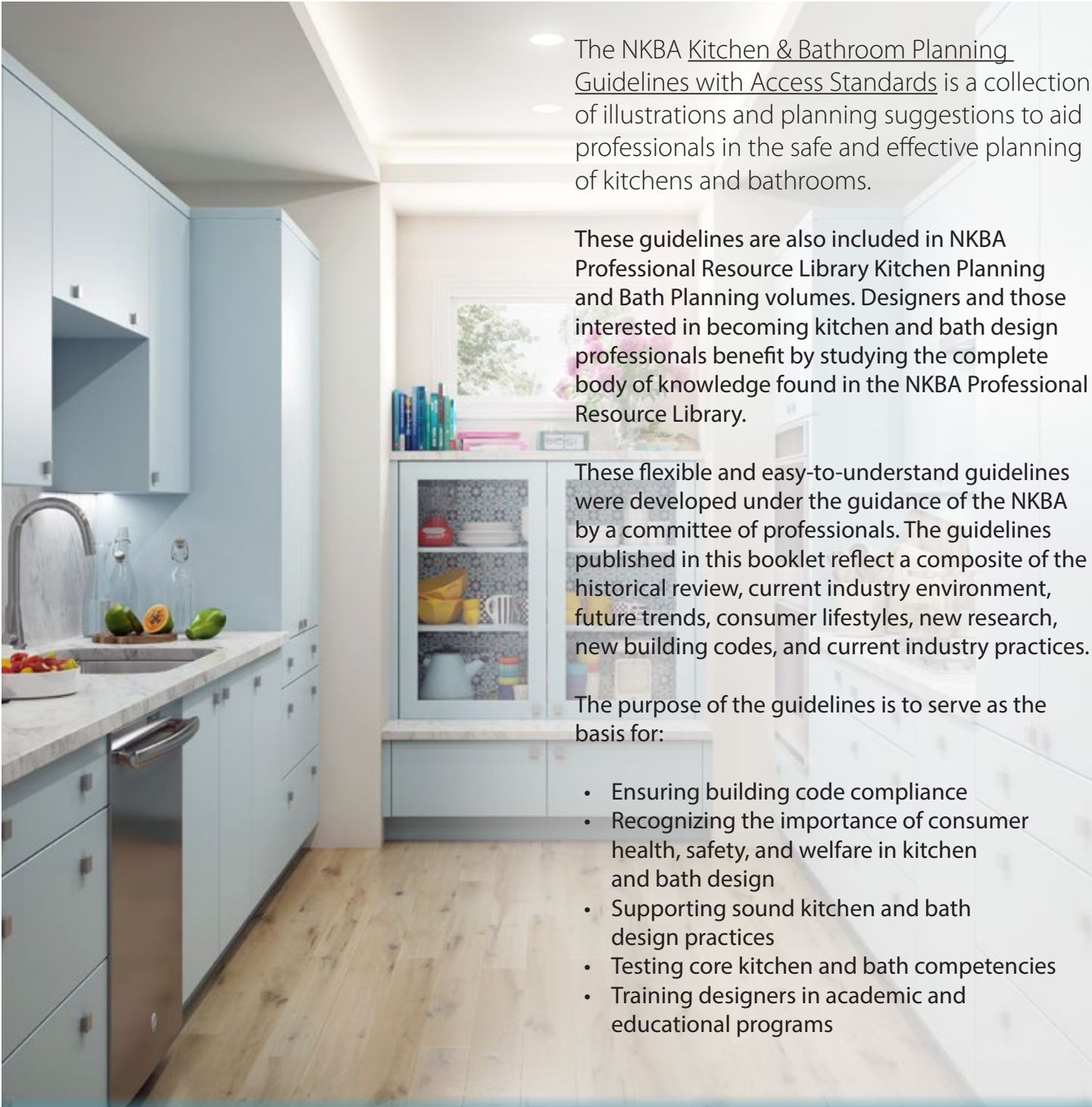

The NKBA Kitchen & Bathroom Planning Guidelines with Access Standards is a collection of illustrations and planning suggestions to aid professionals in the safe and effective planning of kitchens and bathrooms.

These guidelines are also included in NKBA Professional Resource Library Kitchen Planning and Bath Planning volumes. Designers and those interested in becoming kitchen and bath design professionals benefit by studying the complete body of knowledge found in the NKBA Professional Resource Library.

These flexible and easy-to-understand guidelines were developed under the guidance of the NKBA by a committee of professionals. The guidelines published in this booklet reflect a composite of the historical review, current industry environment, future trends, consumer lifestyles, new research, new building codes, and current industry practices.

The purpose of the guidelines is to serve as the basis for:

- Ensuring building code compliance
- Recognizing the importance of consumer health, safety, and welfare in kitchen and bath design
- Supporting sound kitchen and bath design practices
- Testing core kitchen and bath competencies
- Training designers in academic and educational programs

Brought to you by

1st KCMA Environmental Stewardship  
Program Participant

**CANYON CREEK**  
Cabinet Company

[www.canyoncreek.com](http://www.canyoncreek.com)

EPA Evergreen Award Recipient  
ISO 9001 Certified

## Door/Entry

### Recommended:

The clear opening of a doorway should be at least 32" (813 mm) wide. This would require a minimum 2' 10" (864 mm) door.

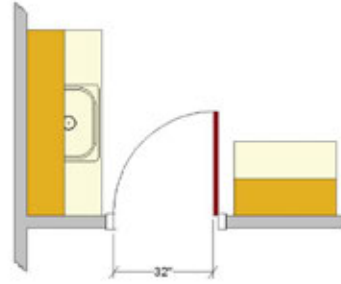

### Code Requirement:

State or local codes may apply.

## Access Standard

### Recommended:

The clear opening of a doorway should be at least 34" (864 mm). This would require a minimum 3' 0" (914 mm) door.

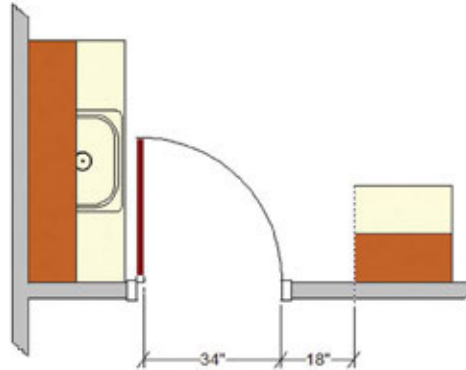

### ICC A117.1-2009 Reference:

- Clear openings of doorways with swinging doors shall be measured between the face of door and stop, with the door open 90 degrees. (404.2.2)
- When a passage exceeds 24" (610 mm) in depth, the minimum clearance increases to 36" (914 mm). (404.2.2)

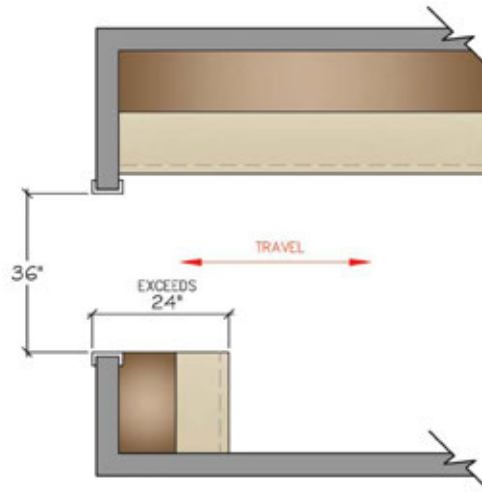

## Door Interference

**Recommended:**

No entry door should interfere with the safe operation of appliances, nor should appliance doors interfere with one another.

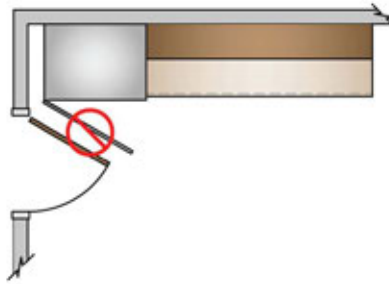

**Code Requirement:**

State or local codes may apply.

## Access Standard

**Recommended:**

In addition, the door area should include clear floor space for maneuvering, which varies according to the type of door and direction of approach.

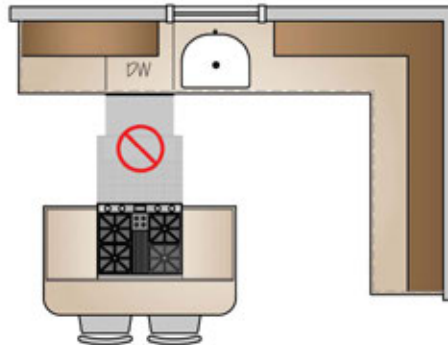

FRONT APPROACH TO SWING DOORS (ACCESS STANDARD 2)

**ICC A117.1-2009 Reference:**

- For a standard hinged door, the clearance on the pull side of the door should be the door width plus 18" x 60" (457 mm x 1524 mm). (404.2.3)
- The clearance on the push side of the door should be the door width by 48" (1219 mm). (404.2.3)

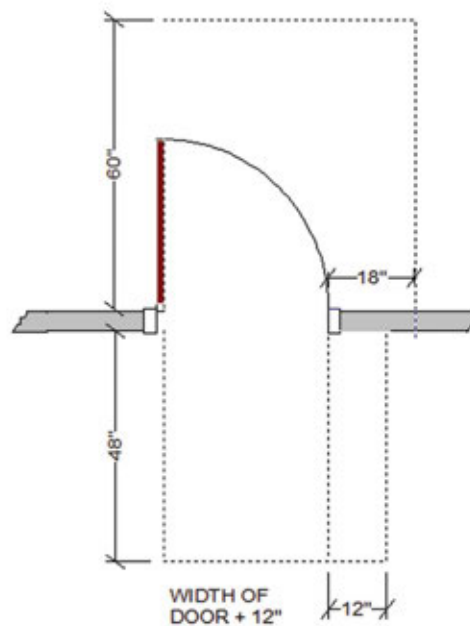

## Distance between Work Centers

### Recommended:

In a kitchen with three work centers,\* the sum of the three traveled distances should total no more than 26' (669 mm), with no single leg of the triangle measuring less than 4' (1219 mm) or more than 9' (2743 mm).

When the kitchen plan includes more than three primary appliance/work centers, each additional travel distance to another appliance/work center should measure no less than 4' (1219 mm) nor more than 9' (2743 mm).

Each leg is measured from the center-front of the appliance/sink.

No work triangle leg intersects an island/peninsula or other obstacle by more than 12" (305 mm).

*\*A major appliance and its surrounding landing/work area form a work center. The distances between the three primary work centers (cooking surface, cleanup/prep sink, and refrigeration storage) form a work triangle.*

### Code Requirement:

State or local codes may apply.

## Access Standard

### Recommended:

Kitchen guideline recommendation meets Access Standard.

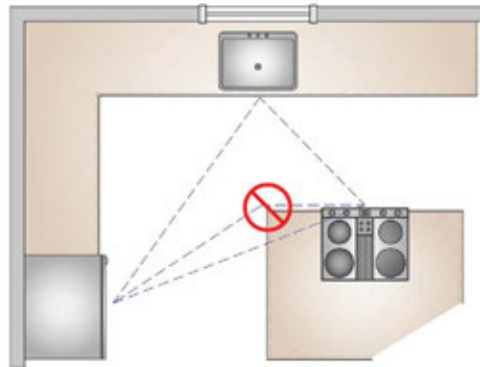
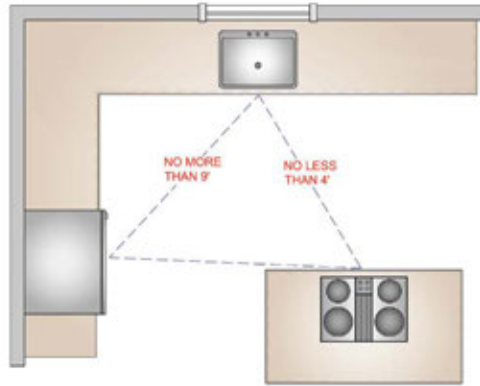

## KITCHEN PLANNING GUIDELINE 4

### Separating Work Centers

**Recommended:**

A full-height, full-depth, tall obstacle\* should not separate two primary work centers.

A properly recessed tall corner unit will not interrupt the workflow and is acceptable.

*\*Examples of a full-height obstacle are a tall oven cabinet, tall pantry cabinet, and refrigerator.*

**Code Requirement:**

State or local codes may apply.

### Access Standard

**Recommended:**

Kitchen guideline recommendation meets Access Standard.

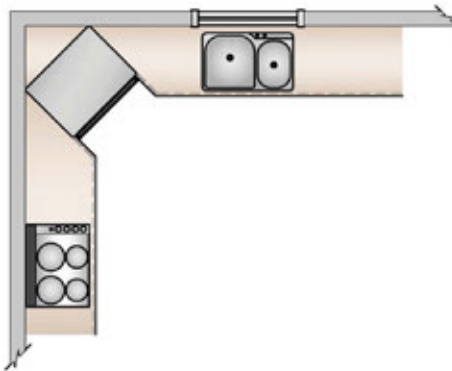
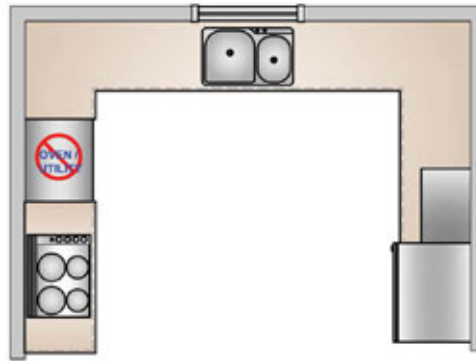

## KITCHEN PLANNING GUIDELINE 5

### Work Triangle Traffic

**Recommended:**

No major traffic patterns should cross through the basic work triangle.

**Code Requirement:**

State or local codes may apply.

### Access Standard

**Recommended:**

Kitchen guideline recommendation meets Access Standard.

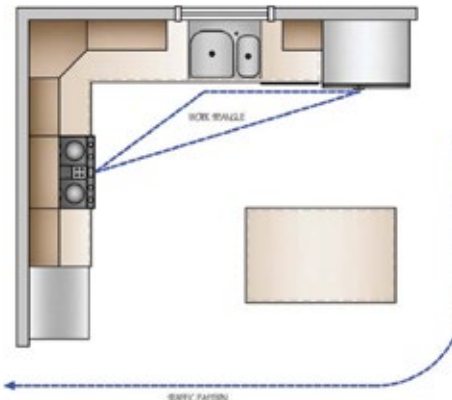

## Work Aisle

**Recommended:**

The width of a work aisle should be at least 42" (1067 mm) for one cook and at least 48" (1219 mm) for multiple cooks. Measure between the counter frontage, tall cabinets, and/or appliances.

**Code Requirement:**

State or local codes may apply.

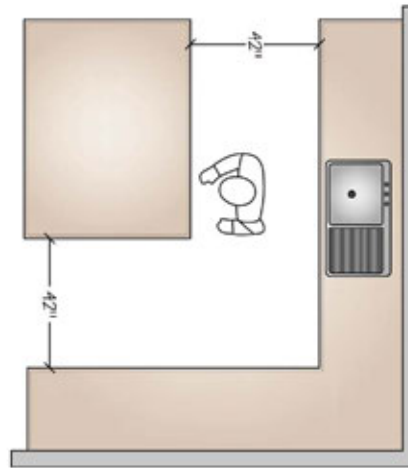

## Access Standard

**Recommended:**

Kitchen guideline recommendation meets Access Standard recommendation. See Code References for specific applications.

**ICC A117.1-2009 Reference:**

A clear floor space of at least 30" x 48" (762 mm x 1219 mm) should be provided at each kitchen appliance. Clear floor spaces can overlap. (305.3, 804.5)

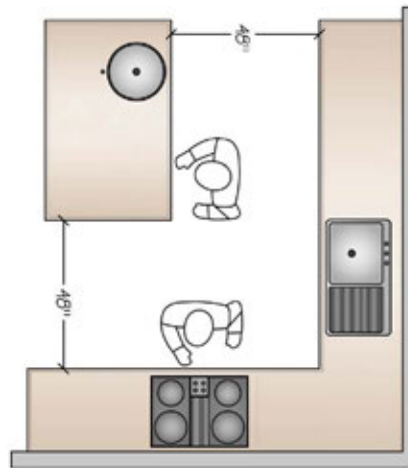

- In a U-shaped kitchen, plan a minimum clearance of 60" (1524 mm) between opposing arms. (804.2, 1003.12)
- Include a wheelchair turning space with a diameter of at least 60" (1524 mm), which can include knee\* and toe\*\* clearances. (304.3)
- A wheelchair turning space could utilize a T-shaped clear space, which is a 60" (1524 mm) square with two 12"



wide × 24" (305 mm × 610 mm) deep areas removed from the corners of the square. This leaves a minimum 36" (914 mm) wide base and two 36" (914 mm) wide arms. T-shaped wheelchair turning spaces can include knee and toe clearances. (304.3)

\*Knee clearance must be 30" (762 mm) wide (36" [914 mm] to use as part of the T-turn) and maintain a 27" (686 mm) high clear space under the cabinet, counter, or sink. At 27" (686 mm) AFF, the depth must be a minimum 8" (203 mm). At 9" (229 mm) AFF, the depth must be a minimum 11" (279 mm). The space from 9" (229 mm) to the floor is considered toe clearance and must be a minimum of 17" (432 mm) and a maximum of 25" (635 mm).

\*\*Toe clearance space under a cabinet or appliance is between the floor and 9" (229 mm) above the floor. Where toe clearance is required as part of a clear floor space, the toe clearance should extend 17" (432 mm) minimum beneath the element. (306.2)

**Code Requirement:**  
State or local codes may apply.

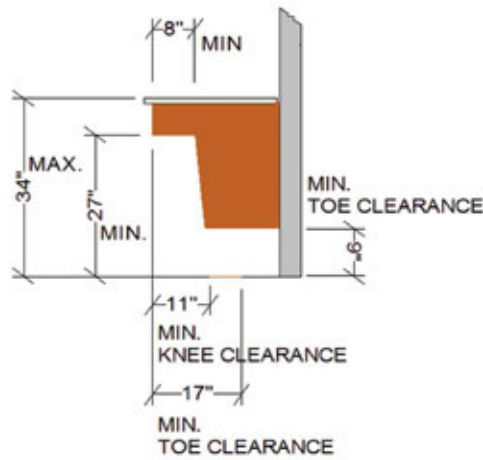
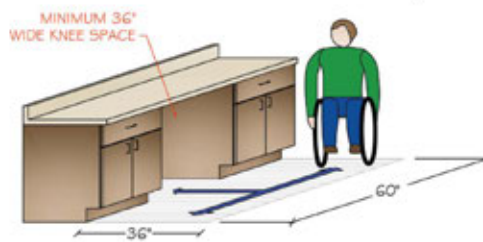
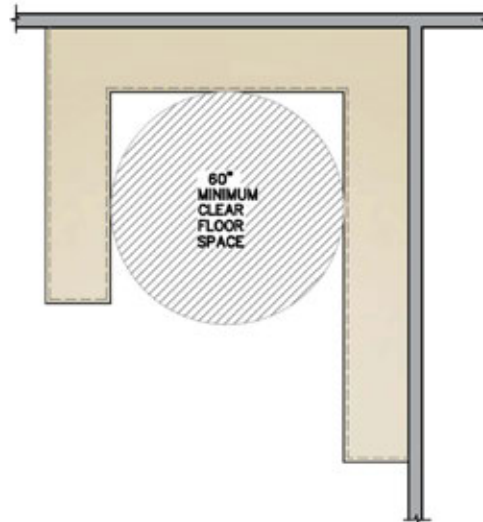

## KITCHEN PLANNING GUIDELINE 7

### Walkway

**Recommended:**

The width of a walkway should be at least 36" (914 mm).

**Code Requirement:**

State or local codes may apply.

### Access Standard

**Recommended:**

If two walkways are perpendicular to each other, one walkway should be at least 42" (1067 mm) wide.

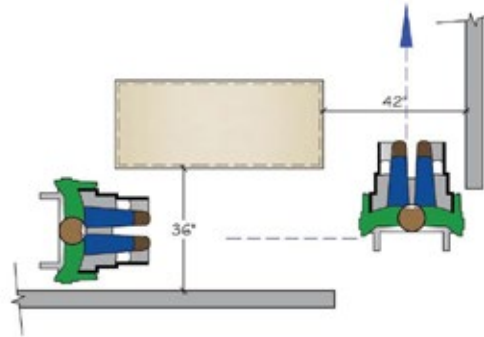
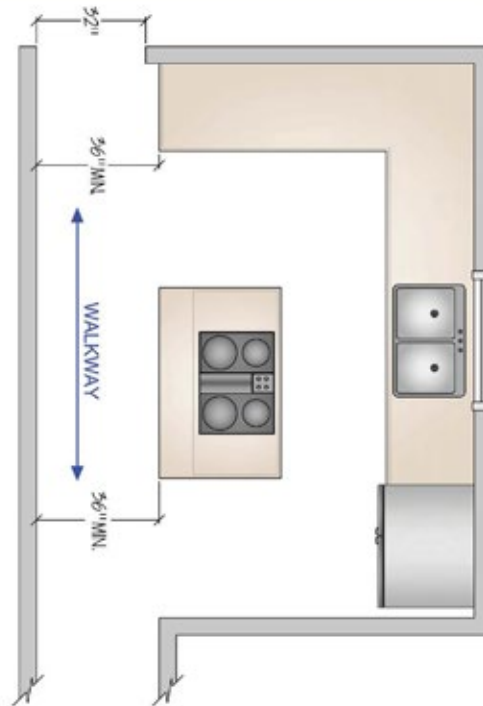



## Traffic Clearance at Seating

### Recommended:

In a seating area where no traffic passes behind a seated diner, allow 32" (813 mm) of clearance from the counter/table edge to any wall or other obstruction behind the seating area.

- a. If traffic passes behind the seated diner, allow at least 36" (914 mm) to edge past.
- b. If traffic passes behind the seated diner, allow at least 44" (1118 mm) to walk past.

### Code Requirement:

State or local codes may apply.

## Access Standard

### Recommended:

In a seating area where no traffic passes behind a seated diner, allow 36" (914 mm) of clearance from the counter/table edge to any wall or other obstruction behind the seating area.

If traffic passes behind the seated diner, plan a minimum of 60" (1524 mm) to allow passage for a person in a wheelchair. This will be impacted by the depth of the knee space.

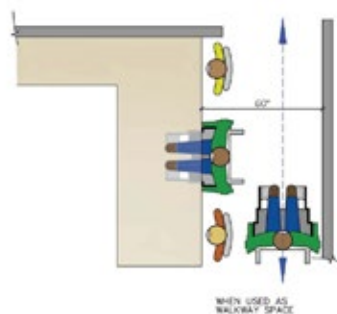
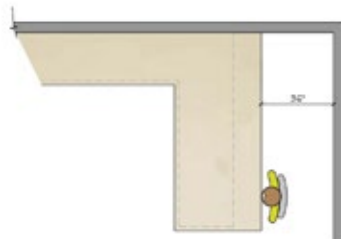
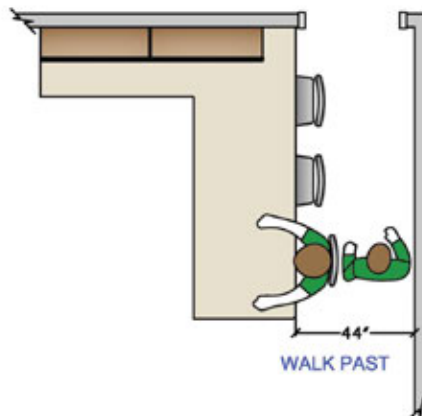
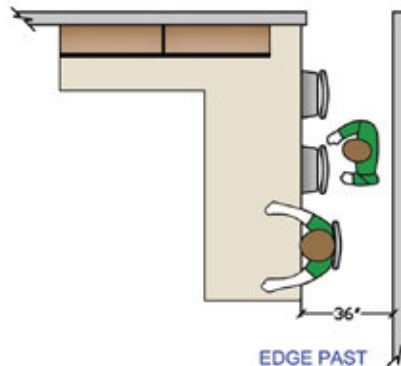
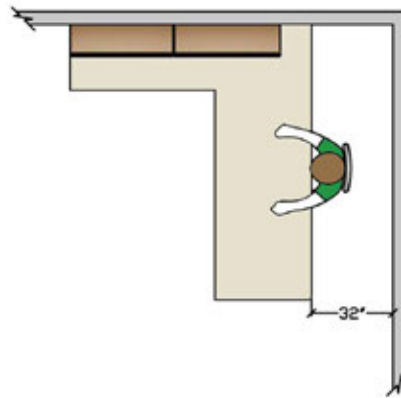

## Seating Clearance

**Recommended:**

Kitchen seating areas should incorporate at least the following clearances:

- a. 30" (762 mm) high tables/counters: allow a 24" wide x 18" deep (610 mm x 457 mm) knee space for each seated diner and at least 18" x (457 mm) of clear knee space.
- b. 36" (914 mm) high counters: allow a 24" wide x 15" deep (610 mm x 381mm) knee space for each seated diner and at least 15" (381 mm) of clear knee space.
- c. 42" (110 cm) high counters: allow a 24" wide x 12" deep (610 mm x 305 mm) knee space for each seated diner and 12" (305 mm) of clear knee space.

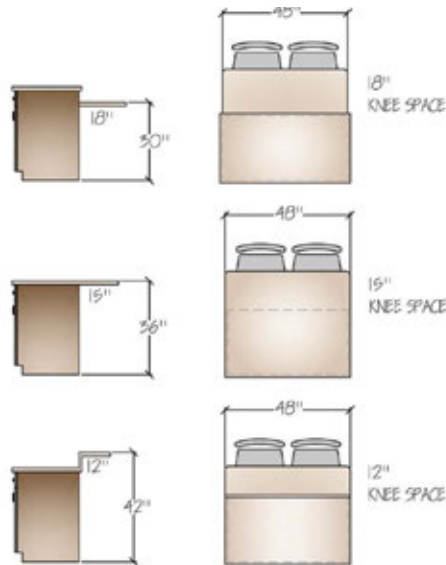

**Code Requirement:**

State or local codes may apply.

## Access Standard

**Recommended:**

Kitchen seating areas should be 28"-34" (711 mm-864 mm) high x 30"-36" (762 mm-914 mm) wide x 17"-25" (432 mm-635 mm) deep to better accommodate people of various sizes or those using a mobility aid.

Recommended minimum size for a knee space at a table or counter is 36" wide x 27" high x 17" deep (914 mm wide x 686 mm high x 432 mm deep).

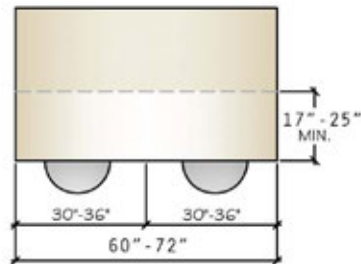

## Cleanup/Prep Sink Placement

**Recommended:**

If a kitchen has only one sink, locate it adjacent to or across from the cooking surface and refrigerator.

**Code Requirement:**

State or local codes may apply.

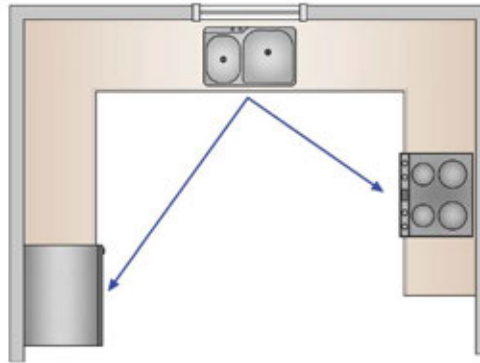

## Access Standard

**Recommended:**

Plan knee spaces at the sink to allow for a seated user. Recommended minimum size for a knee space is 36" wide × 27" high × 8" deep (914 mm × 686 mm × 203 mm), increasing to 17" (432 mm) deep in the toe space, which extends 9" (229 mm) from the floor. Insulation for exposed pipes should be provided.

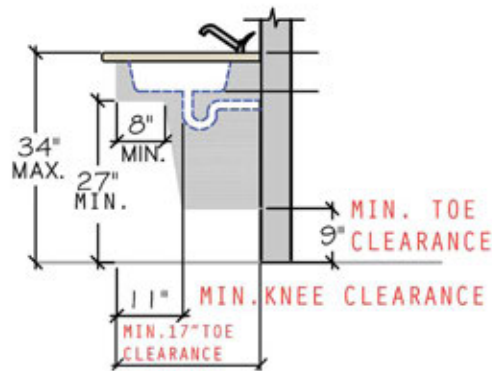

**ICC A117.1-2009 Reference:**

- The sink should be no more than 34" (864 mm) high or adjustable between 29" and 36" (737 mm and 914 mm). (1003.12.4.2)
- Exposed water supply and drainpipes under sinks should be insulated or otherwise configured to protect against contact. There should be no sharp or abrasive surfaces under sinks. (1003.12.4.4)

## Cleanup/Prep Sink Landing Area

### Recommended:

Include at least a 24" (610 mm) wide landing area\* to one side of the sink and at least an 18" (457 mm) wide landing area on the other side.

If all of the countertop at the sink is not the same height, then plan a 24" (610 mm) landing area on one side of the sink and 3" (76 mm) of countertop frontage on the other side, both at the same height as the sink.

The 24" (610 mm) of recommended landing area can be met by 3" (76 mm) of countertop frontage from the edge of the sink to the inside corner of the countertop if no more than 21" (533 mm) of countertop frontage is available on the return.

\*Landing area is measured as countertop frontage adjacent to a sink and/or an appliance. The countertop must be at least 16" (406 mm) deep and must be 28" to 45" (711 mm to 1143 mm) above the finished floor to qualify.

### Code Requirement:

State or local codes may apply.

## Access Standard

### Recommended:

For a parallel approach for a person using a wheelchair, allow a minimum of 24" (610 mm) of countertop frontage from the centerline of the sink to the returning counter.

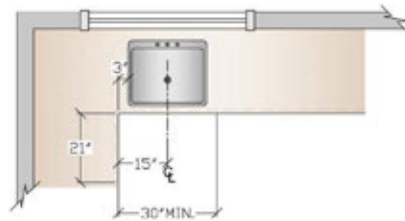
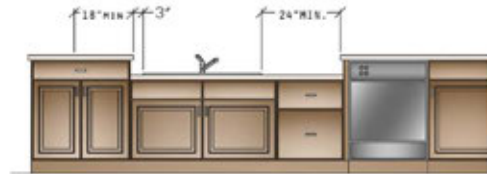

## Preparation/Work Area

### Recommended:

Include a section of continuous countertop at least 36" wide × 24" deep (914 mm × 610 mm) immediately next to a sink for a primary preparation/work area.

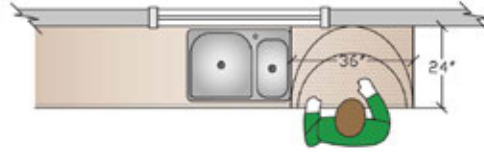

### Code Requirement:

State or local codes may apply.

### Access Standard

#### Recommended:

A section of continuous countertop at least 30" (762 mm) wide with a permanent or adaptable knee space should be included somewhere in the kitchen.

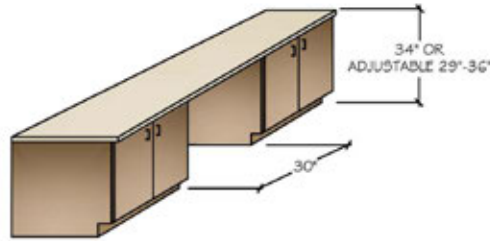

See Access Standard 6 for knee clearance specifications.

### ICC A117.1-2009 Reference:

- In a kitchen, there should be at least one 30" (762 mm) wide section of counter, 34" (864 mm) high maximum or adjustable from 29" to 36" (737 mm to 914 mm). Cabinetry can be added under the work surface, provided it can be removed or altered without removal or replacement of the work surface, and provided the finished floor extends under the cabinet. (1003.12.3)

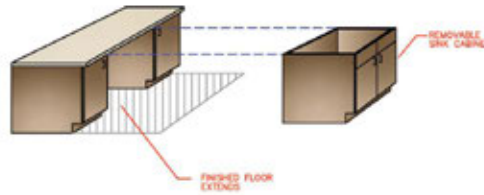

## Dishwasher Placement

**Recommended:**

Locate nearest edge of the primary dishwasher within 36" (914 mm) of the nearest edge of a cleanup/prep sink.

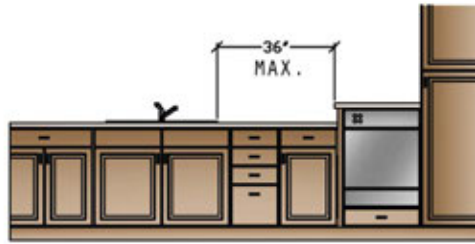

Provide at least 21"\* (533 mm) of standing space between the edge of the dishwasher and countertop frontage, appliances and/or cabinets, which are placed at a right angle to the dishwasher.

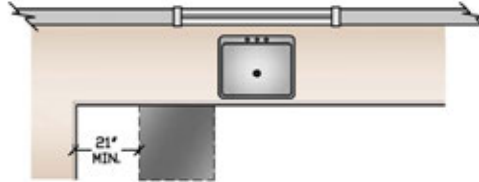

*\*In a diagonal installation, the 21" (533 mm) is measured from the center of the sink to the edge of the dishwasher door in an open position.*

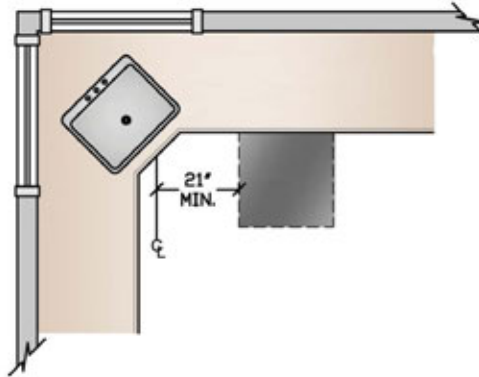

**Code Requirement:**

State or local codes may apply.

### Access Standard

**Recommended:**

Raise dishwasher 6" to 12" (152 mm to 305 mm) when it

can be planned with appropriate landing areas at the same height as the sink.

**ICC A117.1-2009 Reference:**

- A clear floor space of at least 30" x 48" (762 mm x 1219 mm) should be positioned adjacent to the dishwasher door. The dishwasher door in the open position should not obstruct the clear floor space for the dishwasher or the sink. (1003.12.5.3)

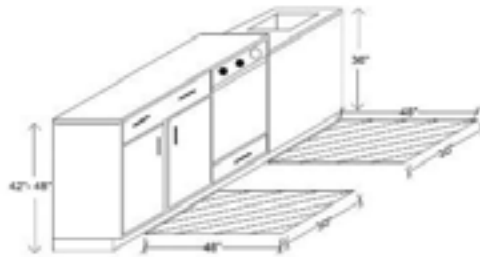

## KITCHEN PLANNING GUIDELINE 14

### Waste Receptacles

**Recommended:**

Include at least two waste receptacles. Locate one near each of the cleanup/prep sink(s) and a second for recycling either in the kitchen or nearby.

**Code Requirement:**

State or local codes may apply.

**Access Standard****Recommended:**

Kitchen guideline recommendation meets Access Standard.

## KITCHEN PLANNING GUIDELINE 15

### Auxiliary Sink

**Recommended:**

At least 3" (76 mm) of countertop frontage should be provided on one side of the auxiliary sink, and 18" (457 mm) of countertop frontage on the other side, both at the same height as the sink.

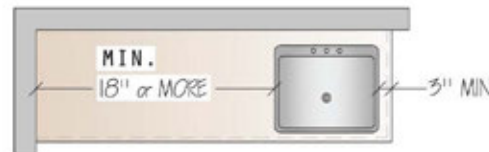
**Code Requirement:**

State or local codes may apply.

**Access Standard****Recommended:**

Plan a knee space at, or adjacent to, the auxiliary sink.

See Access Standard 6 for knee clearance specifications.

## KITCHEN PLANNING GUIDELINE 16

### Refrigerator Landing Area

**Recommended:**

Include at least:

- a. 15" (381 mm) of landing area on the handle side of the refrigerator, or
- b. 15" (381 mm) of landing area on either side of a side-by-side refrigerator, or
- c. 15" (381 mm) of landing area which is no more than 48" (1219 mm) across from the front of the refrigerator, or

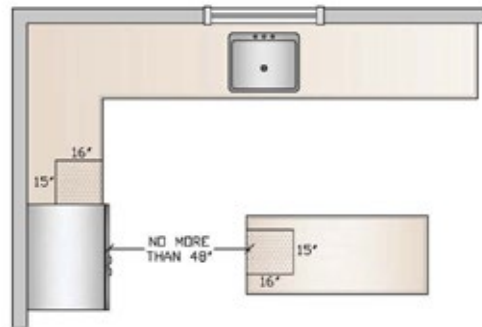

- d. 15" (381 mm) of landing area above or adjacent to any undercounter-style refrigeration appliance.

**Code Requirement:**

State or local codes may apply.

### Access Standard

**Recommended:**

See Code Reference

**ICC A117.1-2009 Reference:**

- A clear floor space of 30" × 48" (762 mm × 1219 mm) should be positioned for a parallel approach to the refrigerator/freezer with the centerline of the clear floor space offset on the handle side 24" (610 mm) maximum from the centerline of the appliance. (804.6.6, 1003.12.6)

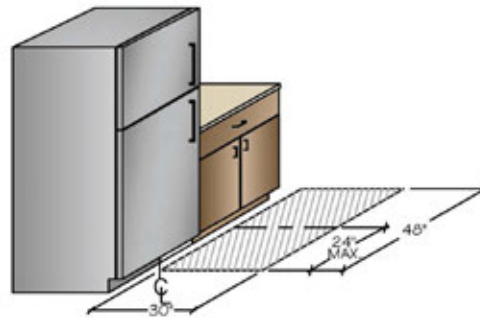

## KITCHEN PLANNING GUIDELINE 17

### Cooking Surface Landing Area

**Recommended:**

Include a minimum of 12" (305 mm) of landing area on one side of a cooking surface and 15" (381 mm) on the other side.



If the cooking surface is at a different countertop height than the rest of the kitchen, then the 12" and 15" (305 mm and 381 mm) landing areas must be at the same height as the cooking surface.

For safety reasons, in an island or peninsula situation, the countertop should also extend a minimum of 9" (229 mm) behind the cooking surface if the counter height is the same as the surface-cooking appliance.



- For an enclosed configuration, a reduction of clearances shall be in accordance with the appliance manufacturer's instructions or per local codes. (This may not provide adequate landing area.) (IRC M 1901.2) (IRC E 4101.2)



**Code Requirement:**

State or local codes may apply.

**Access Standard**

**Recommended:**

Lower the cooktop to 34" (864 mm) maximum height and create a knee space beneath the appliance.

See Access Standard 6 for knee clearance specifications.

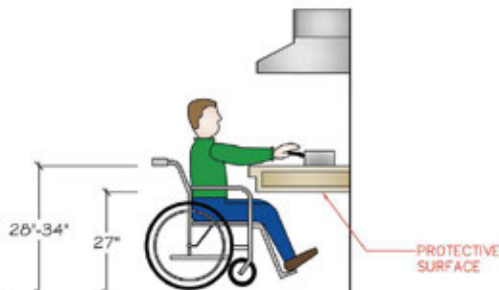

**ICC A117.1-2009 Reference:**

- When a forward-approach clear floor space is provided at the cooktop, it should provide knee and toe clearance, and the underside of the cooktop should be insulated or otherwise configured to prevent burns, abrasions, or electric shock. (1003.12.5.4)
- Where the clear floor space is positioned for a parallel approach, the clear floor space shall be centered on the appliance. (1003.12.5.4)
- The location of cooktop controls should not require reaching across burners. (1003.12.5.4)

## Cooking Surface Clearance

**Recommended:**

Allow 24" (610 mm) of clearance between the cooking surface and a protected noncombustible surface above it.

**Code Requirement:**

- At least 30" (762 mm) of clearance is required between the cooking surface and an unprotected/combustible surface above it. (IRC M 1901.1) (IRC G 244705)
- If a microwave/hood combination is used above the cooking surface, then the manufacturer's specifications should be followed. (IRC M 1504.1) (IRC G 2447.5)

Refer to manufacturer's specifications or local building codes for other considerations.

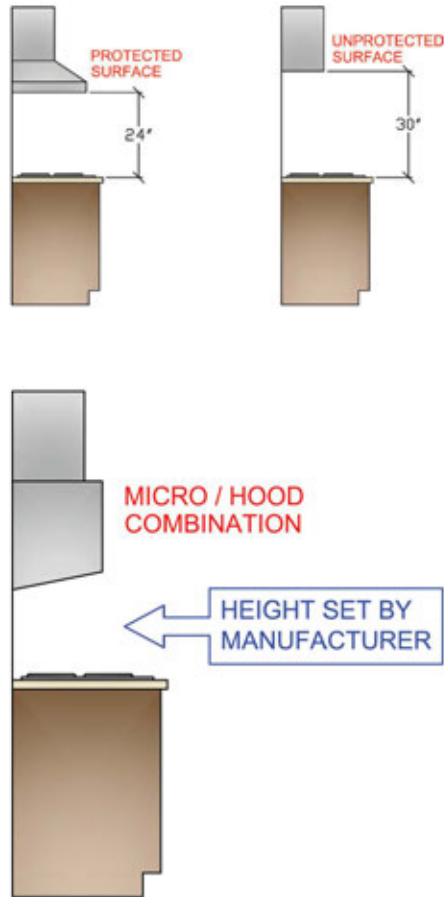

## Access Standard

**Recommended:**

Kitchen guideline recommendation meets Access Standard.

## Cooking Surface Ventilation

### Recommended:

Provide a correctly sized, ducted ventilation system for all cooking surface appliances. The recommended minimum is 150 cubic feet per minute (cfm).

### Code Requirement:

- Manufacturer's installation instructions and specifications must be followed. (IRC G 2407.1, IRC G 2447.1, IRC E 4101.2)
- The minimum required exhaust rate for a ducted hood is 100 cfm and must be ducted to the outside. (IRC M 1507.3)
- Exhaust hood systems capable of exhausting in excess of 400 cfm shall be provided with makeup air at a rate approximately equal to the exhaust air rate. Such makeup air systems shall be equipped with a means of closure and shall be automatically controlled to start and operate simultaneously with the exhaust system. (IRC M 1503.4)
- Refer to local codes for more restricted requirements.

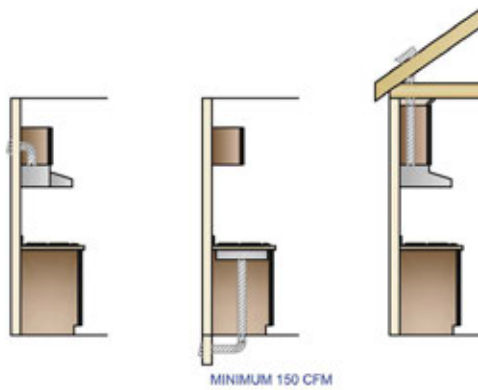

## Access Standard

### Recommended:

Ventilation controls should be placed 15" to 44" (381 mm to 1118 mm) above the floor, operable with minimal effort, easy to read, and with minimal noise pollution. Plan storage of frequently used items 15" to 48" (381 mm to 1219 mm) above the floor.

### ICC A117.1-2009 Reference:

- Operable parts should be operable with one hand and not require tight grasping, pinching, or twisting of the wrist. The force required to activate operable parts should be 5 pounds (2 kg) maximum. (309.4)
- Where a forward or side reach is unobstructed, the high reach should be 48" (1219 mm) maximum, and the low reach should be 15" (381 mm) minimum above the floor. (308.2.1, 308.3.1)
- Where a forward or reach is obstructed by a 20" to 25" (508 mm to 635 mm) deep counter, the high reach should be 44" (1118 mm) maximum. (308.2.2)
- When a side reach is obstructed by a 10" to 24" (254 mm to 610 mm) counter, the high reach should be 46" (1168 mm). (308.3.2)

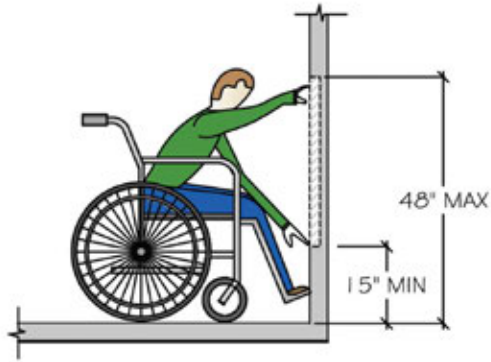

UNOBSTRUCTED FORWARD REACH

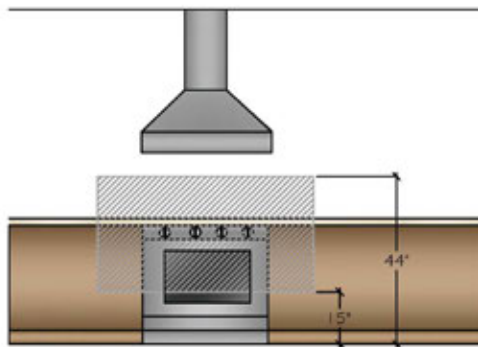

VENTILATION CONTROLS  
WITHIN 15"-44"  
REACH CONTROL

## Cooking Surface Safety

**Recommended:**

- a. Do not locate the cooking surface under an operable window.
- b. Window treatments above the cooking surface should not use flammable materials.
- c. A fire extinguisher should be located near the exit of the kitchen away from cooking equipment.
- d. Commercial cooking appliances are not to be installed in residential kitchens. (IRC M 1901.3) (IRC G 2447.2)



UNACCEPTABLE

**Code Requirement:**

State or local codes may apply.

## Access Standard

**Recommended:**

Place fire extinguisher between 15" and 48" (381 mm and 1219 mm) off the finished floor.

Select cooking appliances with the controls located so that there is no need to reach across burners to operate. (1003.12.5.4.4)



ACCEPTABLE

## Microwave Oven Placement

### Recommended:

Locate the microwave oven after considering the user's height and abilities. The ideal location for the bottom of the microwave is 3" (76 mm) below the principle user's shoulder but no more than 54" (1372 mm) above the floor.

If the microwave oven is placed below the countertop the oven bottom must be at least 15" (40 cm) off the finished floor.

### Code Requirement:

State or local codes may apply.

### Access Standard

#### Recommended:

Locate the microwave controls no higher than 46" to 48" (1168 mm to 1219 mm) depending on approach and reach range. (See Access Standard 19.)

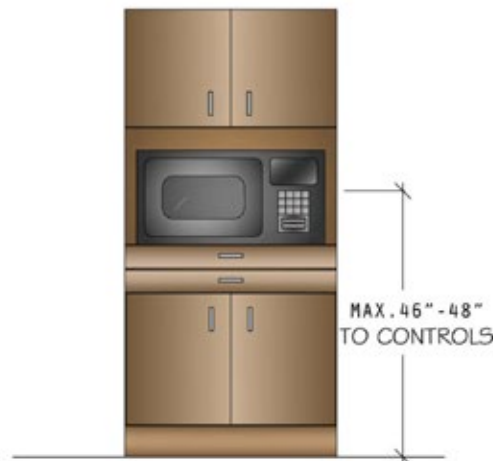
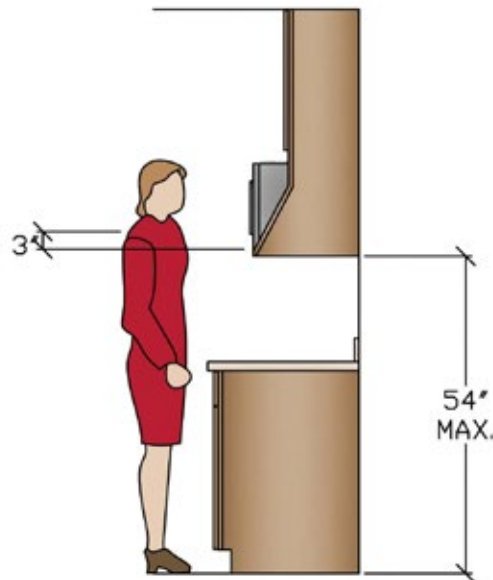

## Microwave Landing Area

**Recommended:**

Provide at least a 15" (381 mm) landing area above, below, or adjacent to the handle side of a microwave oven.

**Code Requirement:**

State or local codes may apply.

### Access Standard

**Recommended:**

Provide landing area in front of or immediately adjacent to the handle side of the microwave.

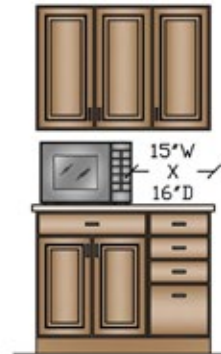
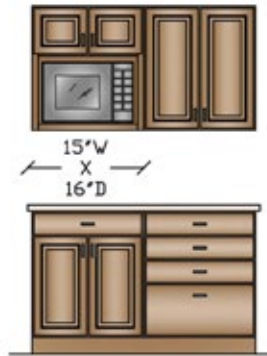
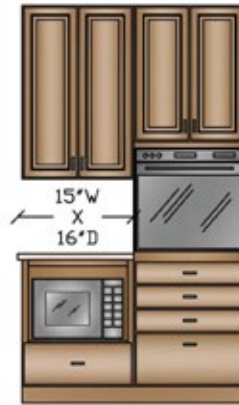

## Oven Landing Area

**Recommended:**

Include at least a 15" (381 mm) landing area next to or above the oven.

At least a 15" (381 mm) landing area that is not more than 48" (1219 mm) across from the oven is acceptable if the appliance does not open into a walkway.

**Code Requirement:**

State or local codes may apply.

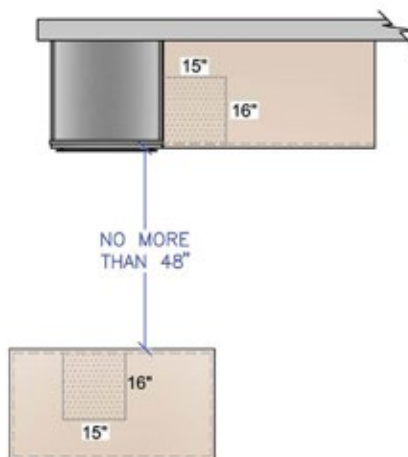

## Access Standard

**Recommended:**

See Code reference.

**ICC A117.1-2009 Reference:**

- For side-opening ovens, the door latch side should be next to a countertop. (1003.12.5.5.2)





## KITCHEN PLANNING GUIDELINE 24

### Combining Landing Areas

**Recommended:**

If two landing areas are adjacent to one another, determine a new minimum for the two adjoining spaces by taking the longer of the two landing area requirements and adding 12" (305 mm).

**Code Requirement:**

State or local codes may apply.

### Access Standard

**Recommended:**

Kitchen guideline recommendation meets Access Standard.

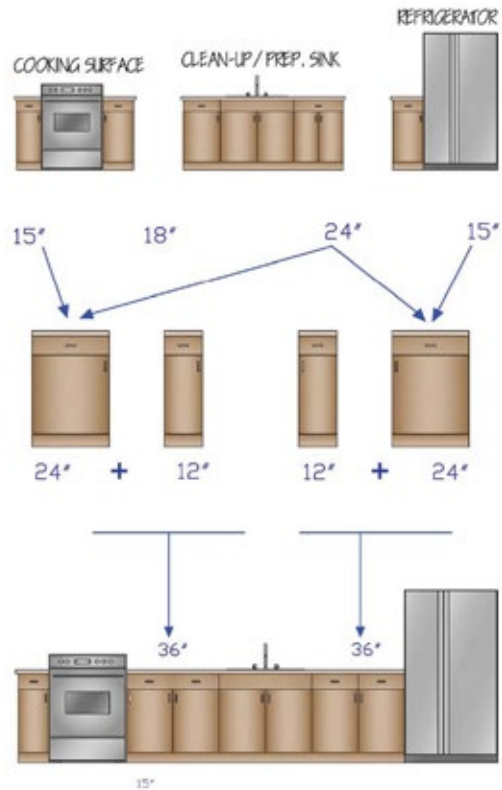

## Countertop Space

**Recommended:**

A total of 158" (4013 mm) of countertop frontage, 24" (610 mm) deep, with at least 15" (381 mm) of clearance above, is needed to accommodate all uses, including landing area, preparation/work area, and storage.

Built-in appliance garages extending to the countertop can be counted towards the total countertop frontage recommendation, but they may interfere with the landing areas.

**Code Requirement:**

State or local codes may apply.

### Access Standard

**Recommended:**

At least two work-counter heights should be offered in the kitchen, with one 28" to 36" (711 mm to 914 mm) above the finished floor and the other 36" to 45" (914 mm to 1143 mm) above the finished floor.

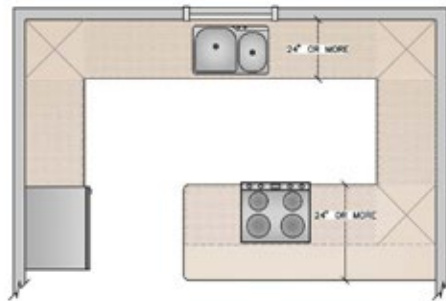

USABLE COUNTER



25

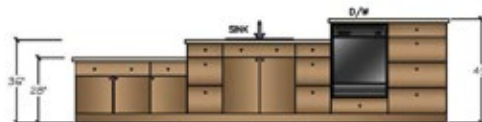

## KITCHEN PLANNING GUIDELINE 26

### Countertop Edges

**Recommended:**

Specify clipped or round corners rather than sharp edges on all counters.

**Code Requirement:**

State or local codes may apply.

### Access Standard

**Recommended:**

Kitchen guideline recommendation meets Access Standard.

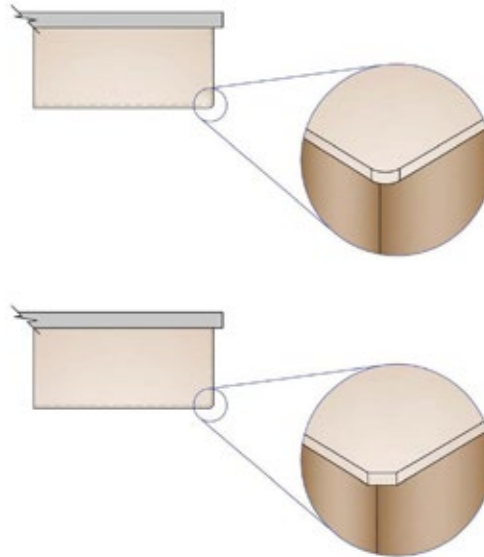

## KITCHEN PLANNING GUIDELINE 27

### Storage

**Recommended:**

The total shelf/drawer frontage\* is:

- a. 1400" (35,560 mm) for a small kitchen (less than 150 square feet) (14 m<sup>2</sup>);
- b. 1700" (43,180 mm) for a medium kitchen (151 to 350 square feet) (14 m<sup>2</sup> to 32.5 m<sup>2</sup>);
- c. 2000" (50,800 mm) for a large kitchen (greater than 350 square feet) (32.5 m<sup>2</sup>).

#### Shelf/Drawer Frontage in Inches

	Small	Medium	Large
Wall	300"	360"	360"
Base	520"	615"	660"
Drawer	360"	400"	525"
Pantry	180"	230"	310"
Misc.	40"	95"	145"

#### Shelf/Drawer Frontage in Millimeters

	Small	Medium	Large
Wall	7620 mm	9144 mm	9144 mm
Base	1320 mm	15621 mm	16764 mm
Drawer	9144 mm	10160 mm	13335 mm
Pantry	4572 mm	5842 mm	7874 mm
Misc.	1016 mm	2413 mm	3683 mm

The totals for wall, base, drawer, and pantry shelf/drawer frontage can be adjusted upward or downward as long as the recommended total stays the same.

Do not apply more than the recommended amount of storage in the miscellaneous category to meet the total frontage recommendation.

Storage areas that are more than 84" (2134 mm) above the floor must be counted in the miscellaneous category.

*\*Shelf and drawer frontage is determined by multiplying the cabinet size by the number and depth of the shelves or drawers in the cabinet, using the following formula: Cabinet width in inches x number of shelf and drawers x cabinet depth in feet (or fraction thereof) = Shelf and Drawer Frontage.*

*Storage/organizing items can enhance the functional capacity of wall, base, drawer, and pantry storage and should be selected to meet user needs.*

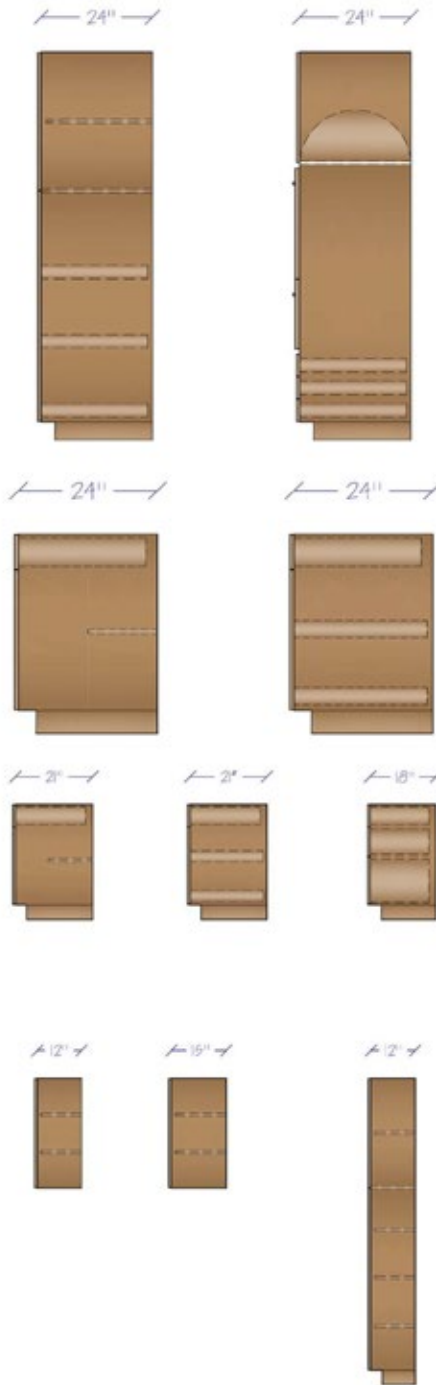

**Code Requirement:**

State or local codes may apply.

**Access Standard**

**Recommended:**

See Guideline 19.

**ICC A117.1-2009 Reference:**

- Where a forward or side reach is unobstructed, the high reach should be 48" (1219 mm) maximum and the low reach should be 15" (381 mm) minimum above the floor. (A117.1 308.2.1, 308.3.1)
- Where a 20" to 25" (508 mm) deep counter obstructs a forward reach, the high reach should be 44" (1118 mm) maximum. (A117.1 308.2.2)
- Where a 10" to 24" (254 mm) counter obstructs a side reach, the high reach should be 46" (1168 mm) maximum. (A117.1308.3.2)

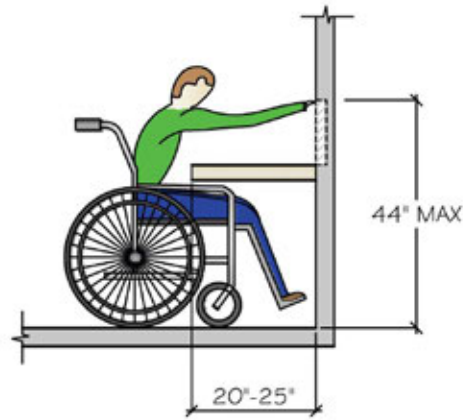

OBSTRUCTED HIGH FORWARD REACH

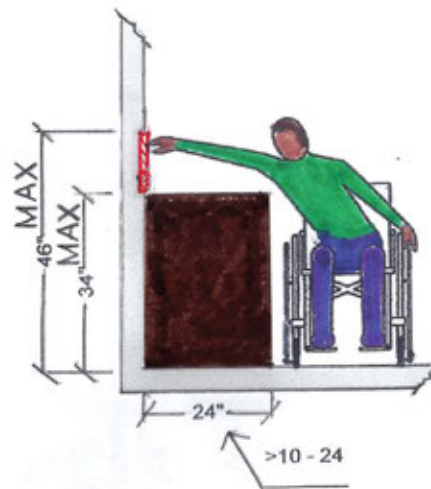

## Storage at Cleanup/Prep Sink

### Recommended:

Of the total recommended wall, base, drawer, and pantry shelf/drawer frontage, the following should be located within 72" (1829 mm) of the centerline of the main cleanup/prep sink:

- At least 400" (10,160 mm) for a small kitchen.
- At least 480" (12,192 mm) for a medium kitchen.
- At least 560" (14,224 mm) for a large kitchen.

### Code Requirement:

State or local codes may apply.

## Access Standard

### Recommended:

Plan storage of frequently used items 15" to 48" (381 mm to 1219 mm) above the floor.

### ICC A117.1-2009 Reference:

- See Access Standard 19 for reach specifications.

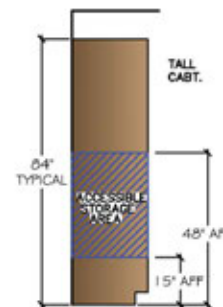
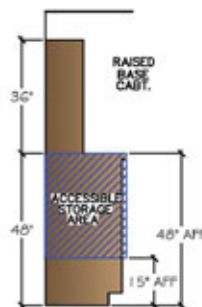
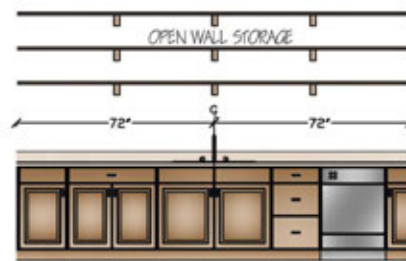
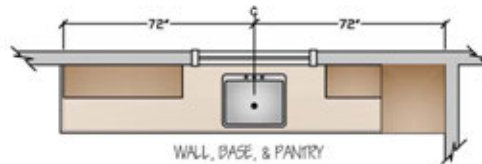
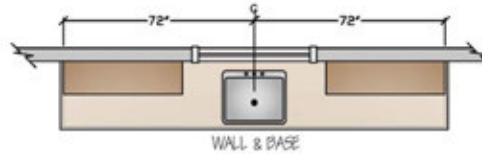
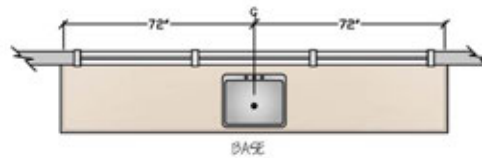

## KITCHEN PLANNING GUIDELINE 29

### Corner Cabinet Storage

**Recommended:**

At least one corner cabinet should include a functional storage device.

This guideline does not apply if there are no corner cabinets.

**Code Requirement:**

State or local codes may apply.

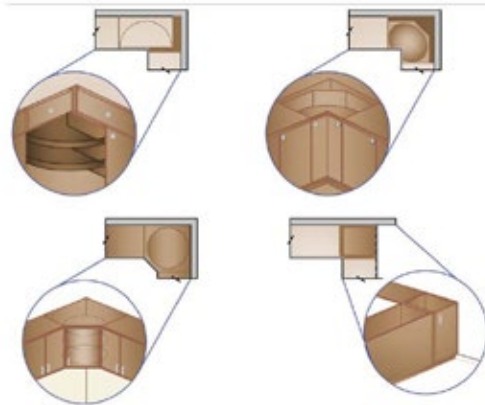

### Access Standard

**Recommended:**

Kitchen guideline recommendation meets Access Standard.

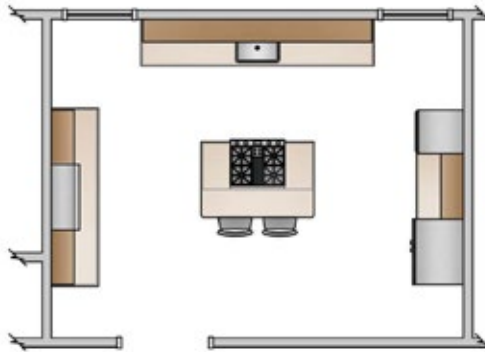

## KITCHEN PLANNING GUIDELINE 30

### Electrical Receptacles

**Code Requirement:**

- GFCI (Ground-fault circuit-interrupter) protection is required on all receptacles servicing countertop surfaces within the kitchen. (IRC E 3902.6)

Refer to IRC E 3901.3 through E 3901.4.5 for receptacle placement and locations.

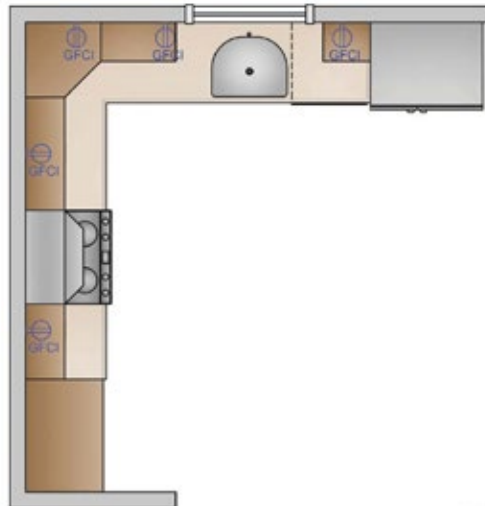

### Access Standard

**Recommended:**

See Code Reference.

**Code Reference:**

See Access Standard 19 for reach and control specifications.

## Lighting

### Recommended:

In addition to general lighting required by code, every work surface should be well illuminated by appropriate task lighting.

### Code Requirement:

- At least one wall switch-controlled light must be provided. Switch must be placed at the entrance. (IRC E 3903.2)
- Window/skylight area, equal to at least 8% of the total square footage of the kitchen, or a total living space that includes a kitchen, is required. (IRC R 303.1, IRC R 303.2)

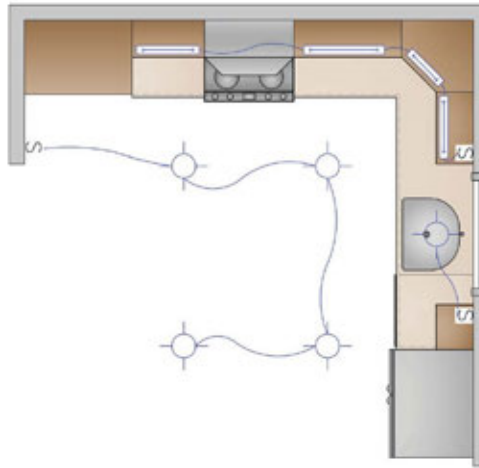

## Access Standard

### Recommended:

Lighting should be from multiple sources and adjustable.

### ICC A117.1-2009 Reference:

- See Access Standard 19 for reach and control specifications.